

 **VAHLE**

BOK-System

Power & Data supply with support beam

SYSTEMS IN MOTION

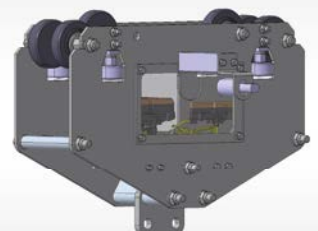
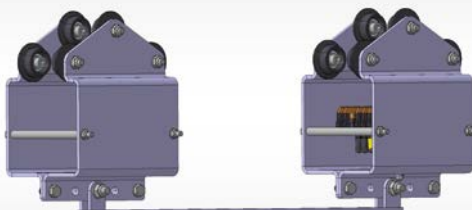

BOK | Power, Data, Positioning & Support

The compact BOK system has proven itself for many years in various assembly, testing, commissioning and battery charging applications. Able to support high loads, BOK is especially useful with production and assembly conveyors when hand tools or control monitors are required.

The BOK system is comprised of a low profile single aluminum track with specially designed compact hangers installed at the bottom flange of the track. The compact hangers accept VAHLE U10 conductors for electric current supply as well as the APOS

positioning system and a leaking wave cable for data transmission requirements.

With these components you can supply current, positioning and data transmission simultaneously. Support carriers are inserted into the aluminum track and manually positioned as required. Carriers can support loads of 70 lbs, 140 lbs or 550 lbs and can be equipped with structural racks to accept tools, instruments or monitors as required in order to create highly efficient, easily moveable workstations.

Areas of application

- Screw fastener technology at production and assembly lines
- Commissioning sections
- Test installations at assembly lines
- Battery charging systems

System specifics

- Aluminum support track profile above assembly line
- Electrical current supply along entire length of line
- Carriers available for up to 550 lbs load capacity
- Bi-directional operation

Type	Load capacity	Track hanger support distance
Single carrier	110 lbs	max. 3 m
Double carrier	220 lbs	max. 3 m
Single carrier (heavy duty)	550 lbs	max. 2 m

Please Note: Additional information, including U10 and APOS technical data, can be found by visiting our website at www.vahle.de/en or contacting us directly

Structural racks

Support racks to meet specific customer requirements can be supplied.

- variable support rack in modular construction
- manufactured to customer requirements
- highly adaptable to accept tools and instruments
- expandable and able to retrofit

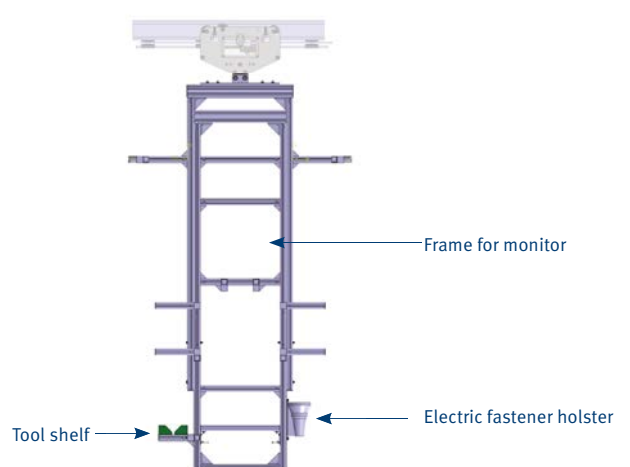
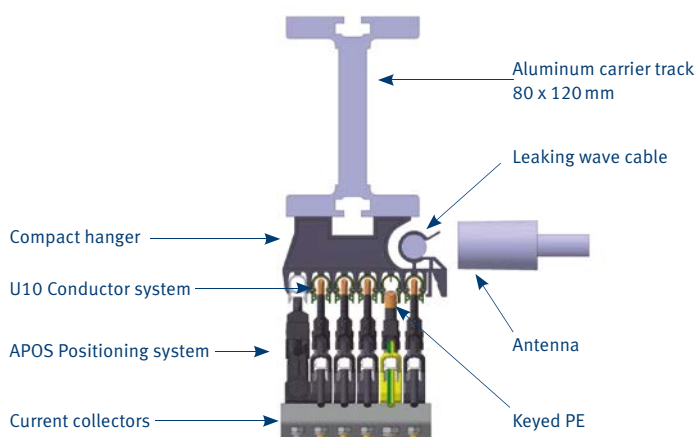

BOK-System

Aluminum carrier track including U 10 Conductors and components,
Track hangers and joint splices

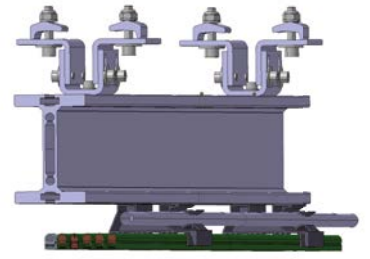

Type	Description	Weight kg/m	Order No.
BOK-SYSTEM 4-POLES+PEVP	BOK-System 5 poles (complete)	12,000	144 051
BOK-SYSTEM 5-POLES+PEVP	BOK-System 6 poles (complete)	12,500	144 052

Single carrier

Load capacity: 110 lbs

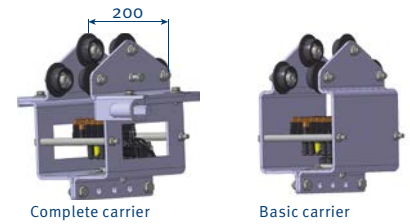

Type	Versions avail.	Current collectors	Weight kg	Order No.
TW-200-BOK-1-KDS2/40-A	basic	5 poles	7,700	144 317
TW-200-BOK-1-KDS2/40-AA	basic	6 poles	7,800	143 865
TW-200-BOK-F-A-D-S-1-SA-KDS2/40-A	complete	5 poles	9,200	10 001 473
TW-200-BOK-F-A-D-S-1-SA-KDS2/40-AA	complete	6 poles	9,300	144 321

Double carrier

Load capacity: 220 lbs

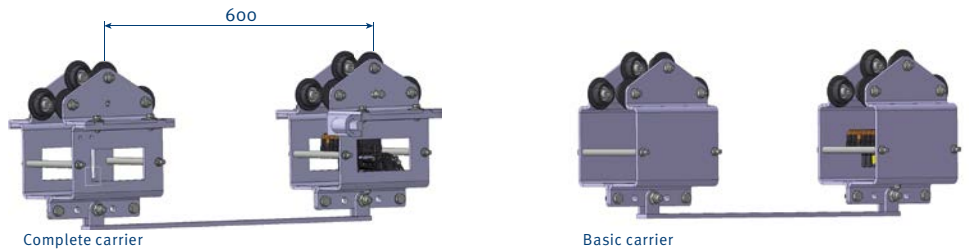

Type	Versions avail.	Current collectors	Weight kg	Order No.
TW-DTW600-BOK-1-SA-KDS2/40-A	basic	5 poles	17,000	144 083
TW-DTW600-BOK-1-SA-KDS2/40-AA	basic	6 poles	17,100	143 863
TW-DTW600-BOK-F-A-D-S-1-SA-KDS2/40-A	complete	5 poles	19,300	10 001 955
TW-DTW600-BOK-F-A-D-S-1-SA-KDS2/40-AA	complete	6 poles	19,400	144 092

Single carrier (heavy duty)

Load capacity: 550 lbs

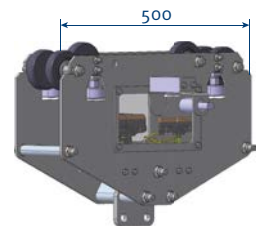

Type	Current collectors	Weight kg	Order No.
TW-500-BOK-A-S-1-KDS2/40-A	5 poles	21,661	144 082
TW-500-BOK-A-S-1-KDS2/40-AD	6 poles	21,800	144 084

Scope of delivery and services

Catalog no.

1 Open conductor systems	
Open conductor systems	1a
2 Insulated conductor systems	
U10	2a
FABA 100	2b
U15, U25, U35	2c
U20, U30, U40	2d
3 Compact conductor systems	
VKS 10	3a
VKS - VKL	3b
VMT	3c
4 Enclosed conductor systems	
KBSL - KSL	4a
KBH	4b
MKH	4c
LSV - LSVG	4d
5 Contactless power supply	
Contactless power supply (CPS®)	5a
6 Data transmission	
VAHLE Powercom®	6a
Slotted Microwave Guide (SMG)	6b
7 Positioning systems	
VAHLE APOS®	7a
VAHLE APOS® Optic	7b
8 Festoon systems and cables	
Festoon systems for □-tracks	8a
Festoon systems for flatform cables on I-tracks	8b
Festoon systems for round cables on I-tracks	8c
Festoon systems for ◇-tracks	8d
Cables	8e
9 Reels	
Spring-operated cable reels	9a
Motor-powered cable reels	9b
10 Other	
Battery charging systems	10a
Heavy enclosed conductor systems	10b
Tender	10c
Contact wire	10d
11 Automotive Handling	
Control systems	11a
BOK	11b
Assemblies / Commissioning	
Spare parts / Maintenance service	



DQS certified in accordance with DIN EN ISO 9001:2008
OHSAS 18001 (Reg.No. 003140 QM OH)



2526127/en-1000-10/15